



ARCHITECTURAL PROFILES TECNODECK

CATALOG
PAC 02/2023

www.tecnodeck.net

TECNODECK PROFILES

AVAILABLE COLORS



TROPICAL BROWN



SAND BROWN



LIGHT GREIGE



URBAN GREY



VULCANO BLACK

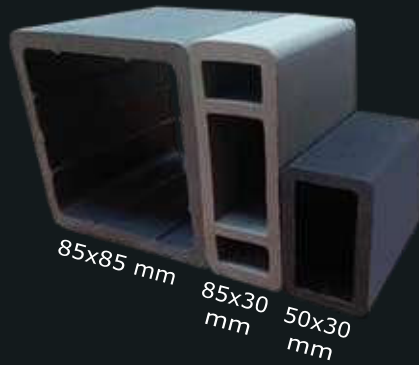

85x85 mm

85x30 mm

50x30 mm

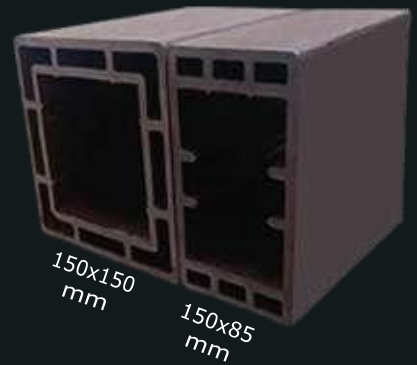

150x150 mm

150x85 mm

NEW
OPTIONAL
PROFILES





Wing Profile
150x33 mm

30x30 mm
50x50 mm
100x25 mm
100x50 mm
150x50 mm
200x80 mm
300x100 mm

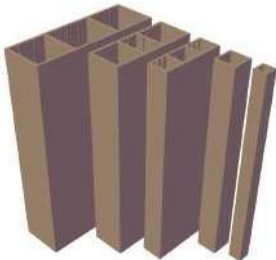
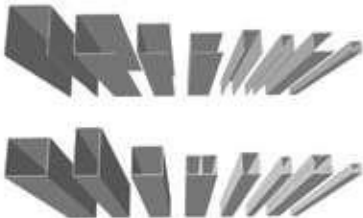



INDEX	PAGE
ARCHITECTURAL PROFILES	4
ARCHITECTURAL PROFILES CAPS	7
UNIONS	9
	TECHNICAL FEATURES ARCHITECTURAL PROFILES 10
	TECHNICAL FEATURES REINFORCEMENT PROFILES 12



ARCHITECTURAL PROFILES

TECNODECK PROFILE 36x30mm	ALU PROFILE 20x25mm	
		Tecnodeck Profile 36x30mm ($\pm 1\text{mm}$) = 0,687 Kg/m 36x30mm Light Greige ($\pm 1\text{mm}$) = 0,687 Kg/m Alu Profile 20x25mm = 0,443 Kg/m Production Lengths (*) 3 m



(*) See Tecnodeck stock production range

TECNODECK PROFILE 50x30mm	ALU, U-ALU PROFILE 38x20mm	
	ALU  U-ALU 	Tecnodeck Profile 50x30mm ($\pm 1\text{mm}$) = 0,940 Kg/m 50x30mm Light Greige ($\pm 1\text{mm}$) = 0,940 Kg/m Alu Profile 38x20mm = 0,540 Kg/m U 38x20mm = 0,361 Kg/m Production Lengths (*) 1 - 1,5 - 2 - 3 - 4 m

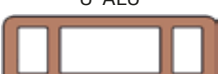
(*) See Tecnodeck stock production range

TECNODECK PROFILE 85x30mm	ALU, U-ALU PROFILE 38x20mm	
	ALU  U-ALU 	Tecnodeck Profile 85x30mm ($\pm 1\text{mm}$) = 1,530 Kg/m 85x30mm Light Greige ($\pm 1\text{mm}$) = 1,530 Kg/m Alu Profile 38x20mm = 0,540 Kg/m U 38x20mm = 0,361 Kg/m Production Lengths (*) 1 - 1,5 - 2 - 3 - 4 m

(*) See Tecnodeck stock production range

TECNODECK PROFILE 85x85mm	ALU PROFILE 68x68mm	
		Tecnodeck Profile 85x85mm ($\pm 1\text{mm}$) = 2,860 Kg/m 85x85mm Light Greige ($\pm 1\text{mm}$) = 2,860 Kg/m Alu Profile 68x68mm = 1,703 Kg/m Production Lengths (*) 1 - 1,5 - 2 - 2,5 - 3 - 4 m

(*) See Tecnodeck stock production range

ARCHITECTURAL PROFILES

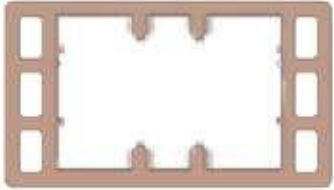
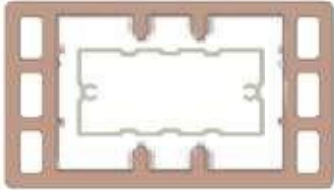

TECNODECK PROFILE 150x85mm	ALU PROFILE 100x48mm	
		<p>Tecnodeck Profile 150x85mm ($\pm 1\text{mm}$) = 5,790 Kg/m 150x85mm Light Greige ($\pm 1\text{mm}$) = 5,790 Kg/m</p> <p>Alu Profile 100x48mm = 2,034 Kg/m</p> <p>Production Lengths (*) 1 - 1,5 - 2 - 2,5 - 3 - 5 - 6 m</p>

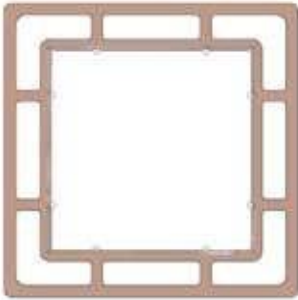
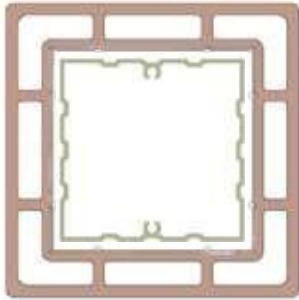
(*) See Tecnodeck stock production range



TECNODECK PROFILE 150x150mm	ALU PROFILE 98x98mm	
		<p>Tecnodeck Profile 150x150mm ($\pm 1\text{mm}$) = 8,550 Kg/m 150x85mm Light Greige ($\pm 1\text{mm}$) = 8,550 Kg/m</p> <p>Alu Profile 98x98mm = 2,646 Kg/m</p> <p>Production Lengths (*) 1 - 1,5 - 2 - 2,5 - 3 - 5 - 6 m</p>

(*) See Tecnodeck stock production range

ARCHITECTURAL PROFILES

TECNODECK SKIN W PROFILE 220x15x36mm	ALU + ALU L PROFILE 38x20mm + L 49x53mm	
		<p>Tecnodeck Profile 220x15x36mm (± 1mm) = 2,94 Kg/m</p> <p>Alu Profile 38x20mm = 0,540 Kg/m L 49x53mm = 2,646 Kg/m</p> <p>Production Lengths (*) 3 m</p>

(*) See Tecnodeck stock production range

TECNODECK STC W PROFILE 220x15x36mm	ALU + ALU L PROFILE 38x20mm + L 49x53mm	
		<p>Tecnodeck Profile 220x15x36mm (± 1mm) = 3,19 Kg/m 220x15x36mm Light Greige (± 1mm) = 3,19 Kg/m</p> <p>Alu Profile 38x20mm = 0,540 Kg/m L 49x53mm = 2,646 Kg/m</p> <p>Production Lengths (*) 3 m</p>

(*) See Tecnodeck stock production range

ARCHITECTURAL PROFILES

CAPS

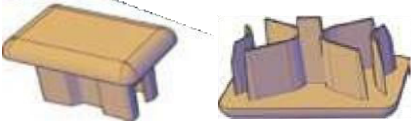
iCAP 50x30mm	
	<p>Tecnodeck Injected Cap 50x30mm ($\pm 1\text{mm}$) = 0,010 Kg/un</p>

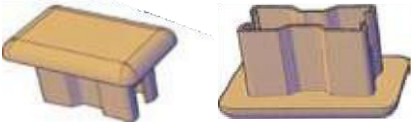

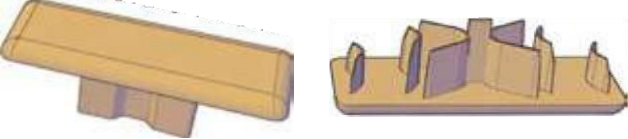
iCAP ALU 50x30mm	
	<p>Tecnodeck Injected Cap - Alu Profile 50x30mm ($\pm 1\text{mm}$) = 0,011 Kg/un</p>

iCAP 85x30mm	
	<p>Tecnodeck Injected Cap 85x30mm ($\pm 1\text{mm}$) = 0,015 Kg/un</p>

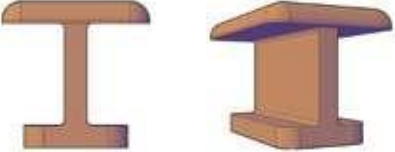

iCAP ALU 85x30mm	
	<p>Tecnodeck Injected Cap - Alu Profile 85x30mm ($\pm 1\text{mm}$) = 0,016 Kg/un</p>

ARCHITECTURAL PROFILES

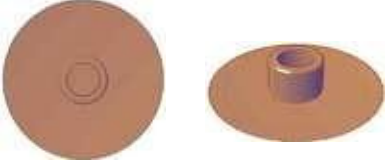
CAPS

<p>CAP G 50x30mm</p>		<p>Tecnodeck Cap G Machined 50x30mm (± 1mm) = 0,018 Kg/un 50x30mm Light Greige (± 1mm) = 0,018 Kg/un</p>
<p>CAP G 85x30mm</p>		<p>Tecnodeck Cap G Machined 85x30mm (± 1mm) = 0,027 Kg/un 85x30mm Light Greige (± 1mm) = 0,027 Kg/un</p>
<p>CAP G 85x85mm</p>		<p>Tecnodeck Cap G Machined 85x85mm (± 1mm) = 0,092 Kg/un 85x85mm Light Greige (± 1mm) = 0,092 Kg/un</p>
<p>SCREW COVER M8 M8</p>		<p>Screw Cover M8 M8 (± 1mm) = 0,251 Kg/un</p>

UNIONS

<p>UNION PA STD ALU 35x17mm</p>	
	<p>Union PA STD ALU 35x17mm (± 1mm) = 0,005 Kg/un</p>
<p>UNION PA STD 42x22mm</p>	
	<p>Union PA STD 42x22mm (± 1mm) = 0,015 Kg/un</p>

TECHNICAL FEATURES

ARCHITECTURAL PROFILES

	TECNODECK PROFILE 36x30mm	
	Alloy	Wood Plastic Composite
	Weight (Kg/m)	0,687
	Density (Kg/dm ³)	1,33
	Tensile Strength (MPa)	22,5
	Modulus of Elasticity (MPa)	2400
	Inercia Momentum X (mm ⁴)	6,07E+04
	Inercia Momentum Y (mm ⁴)	8,49E+04

	TECNODECK PROFILE 50x30mm	
	Alloy	Wood Plastic Composite
	Weight (Kg/m)	0,931
	Density (Kg/dm ³)	1,33
	Tensile Strength (MPa)	22,5
	Modulus of Elasticity (MPa)	2400
	Inercia Momentum X (mm ⁴)	9,11E+04
	Inercia Momentum Y (mm ⁴)	2,07E+05

	TECNODECK PROFILE 85x30mm	
	Alloy	Wood Plastic Composite
	Weight (Kg/m)	1,561
	Density (Kg/dm ³)	1,33
	Tensile Strength (MPa)	22,5
	Modulus of Elasticity (MPa)	2400
	Inercia Momentum X (mm ⁴)	1,39E+05
	Inercia Momentum Y (mm ⁴)	9,00E+05

	TECNODECK PROFILE 85x85mm	
	Alloy	Wood Plastic Composite
	Weight (Kg/m)	2,930
	Density (Kg/dm ³)	1,33
	Tensile Strength (MPa)	22,5
	Modulus of Elasticity (MPa)	2400
	Inercia Momentum X (mm ⁴)	2,24E+06
	Inercia Momentum Y (mm ⁴)	2,24E+06

TECHNICAL FEATURES

ARCHITECTURAL PROFILES

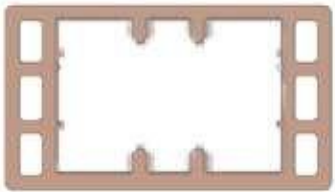
	TECNODECK PROFILE 150x85mm	
	Alloy	Wood Plastic Composite
	Weight (Kg/m)	5,791
	Density (Kg/dm ³)	1,33
	Tensile Strength (MPa)	22,5
	Modulus of Elasticity (MPa)	2400
	Inercia Momentum X (mm ⁴)	4,16E+06
	Inercia Momentum Y (mm ⁴)	1,23E+07

	TECNODECK PROFILE 150x150mm	
	Alloy	Wood Plastic Composite
	Weight (Kg/m)	8,549
	Density (Kg/dm ³)	1,33
	Tensile Strength (MPa)	22,5
	Modulus of Elasticity (MPa)	2400
	Inercia Momentum X (mm ⁴)	1,79E+07
	Inercia Momentum Y (mm ⁴)	1,79E+07

	TECNODECK SKIN W PROFILE 220x15x36mm	
	Alloy	Wood Plastic Composite
	Weight (Kg/m)	2,940
	Density (Kg/dm ³)	1,33
	Tensile Strength (MPa)	22,5
	Modulus of Elasticity (MPa)	2400

	TECNODECK STC W PROFILE 220x15x36mm	
	Alloy	Wood Plastic Composite
	Weight (Kg/m)	3,190
	Density (Kg/dm ³)	1,33
	Tensile Strength (MPa)	22,5
	Modulus of Elasticity (MPa)	2400

TECHNICAL FEATURES

REINFORCEMENT PROFILES

TECNODECK ALU PROFILE 38x20mm	
Alloy	6060 T6
Weight (Kg/m)	0,540
Density (Kg/dm ³)	2,7
Yield Strength (MPa)	150
Tensile Strength (MPa)	190
Vickers Hardness	60
Modulus of Elasticity (MPa)	70000
Modulus of Rigidity (MPa)	27000
Inercia Momentum X (mm ⁴)	1,03E+04
Inercia Momentum Y (mm ⁴)	3,39E+04



TECNODECK ALU-U PROFILE 38x20mm	
Alloy	6060 T6
Weight (Kg/m)	0,361
Density (Kg/dm ³)	2,7
Yield Strength (MPa)	150
Tensile Strength (MPa)	190
Vickers Hardness	60
Modulus of Elasticity (MPa)	70000
Modulus of Rigidity (MPa)	27000
Inercia Momentum X (mm ⁴)	4,05E+03
Inercia Momentum Y (mm ⁴)	2,79E+04



TECNODECK ALU PROFILE 68x68mm	
Alloy	6060 T6
Weight (Kg/m)	1,703
Density (Kg/dm ³)	2,7
Yield Strength (MPa)	150
Tensile Strength (MPa)	190
Vickers Hardness	60
Modulus of Elasticity (MPa)	70000
Modulus of Rigidity (MPa)	27000
Inercia Momentum X (mm ⁴)	4,41E+05
Inercia Momentum Y (mm ⁴)	4,41E+05

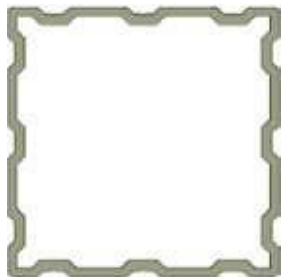

TECHNICAL FEATURES

REINFORCEMENT PROFILES

TECNODECK ALU PROFILE 100x48mm	
Alloy	6060 T6
Weight (Kg/m)	2,034
Density (Kg/dm ³)	2,7
Yield Strength (MPa)	150
Tensile Strength (MPa)	190
Vickers Hardness	60
Modulus of Elasticity (MPa)	70000
Modulus of Rigidity (MPa)	27000
Inercia Momentum X (mm ⁴)	2,72E+05
Inercia Momentum Y (mm ⁴)	9,06E+05



TECNODECK ALU PROFILE 98x98mm	
Alloy	6060 T6
Weight (Kg/m)	2,646
Density (Kg/dm ³)	2,7
Yield Strength (MPa)	150
Tensile Strength (MPa)	190
Vickers Hardness	60
Modulus of Elasticity (MPa)	70000
Modulus of Rigidity (MPa)	27000
Inercia Momentum X (mm ⁴)	1,33E+06
Inercia Momentum Y (mm ⁴)	1,26E+06

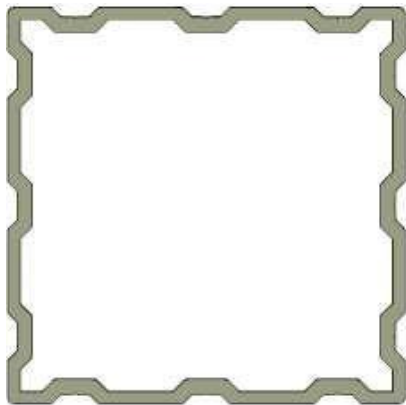

TECNODECK ALU-L PROFILE 68x68mm	
Alloy	6060 T6
Weight (Kg/m)	0,669
Density (Kg/dm ³)	2,7
Yield Strength (MPa)	150
Tensile Strength (MPa)	190
Vickers Hardness	60
Modulus of Elasticity (MPa)	70000
Modulus of Rigidity (MPa)	27000



OPTIONAL PROFILES
CATALOG



PROFILES:

- 30x30mm
 - 50x50mm
 - 100x25mm
 - 100x50mm
 - 150x50mm
 - 200x80mm
 - 300x100mm
 - 150x33 (elíptico)
-
- These profiles are not standard stock production items.
 - Tecnodeck has available the molds for their production, under request for projects.
 - The production of these profiles is subjected to a minimum quantity and the delivery time should be confirmed.

INDEX PAGE

OPTIONAL ARCHITECTURAL PROFILES 17

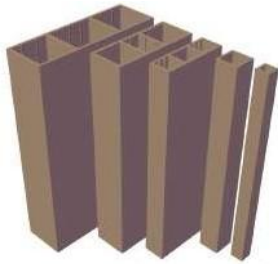



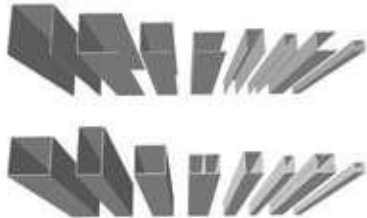



TECHNICAL FEATURES
ARCHITECTURAL PROFILES 20



TECHNICAL FEATURES
REINFORCEMENT PROFILES 22

OPTIONAL ARCHITECTURAL PROFILES

TECNODECK PROFILE 30x30mm	ALU, U-St Zn PROFILE 20x20mm / U20x20mm	
	<div style="display: flex; justify-content: space-around; align-items: center;"> <div style="text-align: center;"> <p>ALU</p>  <p>20x20</p> </div> <div style="text-align: center;"> <p>St Zn</p>  <p>U20x20/1,5</p> </div> </div>	<p>Tecnodeck Profile 30x30mm ($\pm 1\text{mm}$) = 0,534 Kg/m 30x30mm Light Greige ($\pm 1\text{mm}$) = 0,534 Kg/m</p> <p>Alu Profile 20x20mm = 0,386 Kg/m</p> <p>Galvanized Profile U 20x20/1,5mm = 0,867 Kg/m</p>

TECNODECK PROFILE 50x50mm	ALU, U-St Zn PROFILE 38x38mm / U38x38mm	
	<div style="display: flex; justify-content: space-around; align-items: center;"> <div style="text-align: center;"> <p>ALU</p>  <p>38x38</p> </div> <div style="text-align: center;"> <p>St Zn</p>  <p>U38x38/2</p> </div> </div>	<p>Tecnodeck Profile 50x50mm ($\pm 1\text{mm}$) = 1,152 Kg/m 50x50mm Light Greige ($\pm 1\text{mm}$) = 1,152 Kg/m</p> <p>Alu Profile 38x38mm = 0,656 Kg/m</p> <p>Galvanized Profile U 38x38/2mm = 1,697 Kg/m</p>

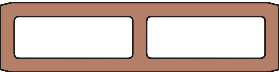
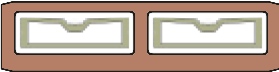

TECNODECK PROFILE 100x25mm	ALU PROFILE 38x10mm	
	<div style="text-align: center;"> <p>ALU</p>  <p>38x10</p> </div>	<p>Tecnodeck Profile 100x25mm ($\pm 1\text{mm}$) = 1,620 Kg/m 100x25mm Light Greige ($\pm 1\text{mm}$) = 1,620 Kg/m</p> <p>Alu Profile 38x10mm = 0,400 Kg/m</p> <p>Production Lengths (*) 1 - 1,5 - 2 - 3 - 4 m</p>

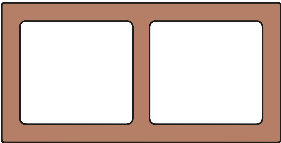
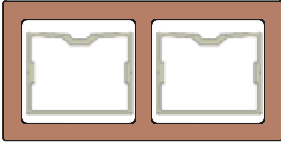

(*) See Tecnodeck stock production range

OPTIONAL ARCHITECTURAL PROFILES

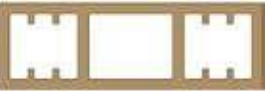

TECNODECK PROFILE 100x50mm	ALU PROFILE 38x30mm	
	<p style="text-align: center;">ALU</p>  <p style="text-align: center;">38x30</p>	<p>Tecnodeck Profile 100x50mm (± 1mm) = 2,610 Kg/m 100x50mm Light Greige (± 1mm) = 2,610 Kg/m</p> <p>Alu Profile 38x30mm = 0,530 Kg/m</p> <p>Production Lengths (*) 1 - 1,5 - 2 - 3 - 4 m</p>

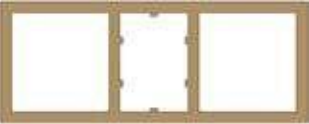

(*) See Tecnodeck stock production range

TECNODECK PROFILE 150x50mm	ALU/ St Zn PROFILE 35x20mm + 45x35mm U35x25mm + U45x35mm	
	<p style="text-align: center;">ALU</p>  <p style="text-align: center;">35x20 45x35 35x20</p> <p style="text-align: center;">St Zn</p>  <p style="text-align: center;">U35x25 U45x35 U35x25</p>	<p>Tecnodeck Profile 150x50mm (± 1mm) = 3,655 Kg/m 150x50mm Light Greige (± 1mm) = 3,655 Kg/m</p> <p>Alu Profile 35x20mm = 0,530 Kg/m 45x35mm = 0,821 Kg/m</p> <p>Galvanized Profile U 35x25/2mm = 1,397 Kg/m U 45x35/2mm = 1,871 Kg/m</p>

TECNODECK PROFILE 200x80mm	ALU/ St Zn PROFILE 60x40mm + 60x60mm U60x40mm + U60x60mm	
	<p style="text-align: center;">ALU</p>  <p style="text-align: center;">60x60 60x40 60x60</p> <p style="text-align: center;">St Zn</p>  <p style="text-align: center;">U60x60 U60x40 U60x60</p>	<p>Tecnodeck Profile 200x80mm (± 1mm) = 5,877 Kg/m 200x80mm Light Greige (± 1mm) = 5,877 Kg/m</p> <p>Alu Profile 60x40mm = 1,037 Kg/m 60x60mm = 1,253 Kg/m</p> <p>Galvanized Profile U 60x40/2mm = 2,424 Kg/m U 60x60/2mm = 2,732 Kg/m</p>

OPTIONAL ARCHITECTURAL PROFILES

TECNODECK PROFILE 300x100mm	ALU/ St Zn PROFILE 80x80mm + 100x40mm U80x80mm + U100x40mm	
	<p style="text-align: center;">ALU</p>  <p style="text-align: center;">80x80 100x40 80x80</p> <p style="text-align: center;">St Zn</p>  <p style="text-align: center;">U80x80 U100x40 U80x80</p>	<p>Tecnodeck Profile 300x100mm ($\pm 1\text{mm}$) = 8,102 Kg/m 300x100mm Light Greige ($\pm 1\text{mm}$) = 8,102 Kg/m</p> <p>Alu Profile 80x80mm = 1,685 Kg/m 100x40mm = 1,143 Kg/m</p> <p>Galvanized Profile U 80x80/2mm = 3,688 Kg/m U 100x40/2mm = 4,320 Kg/m</p>

TECNODECK PROFILE 150x33mm	ALU PROFILE 38x20mm U38x20mm	
	<p style="text-align: center;">ALU</p>  <p style="text-align: center;">U-ALU</p> 	<p>Tecnodeck Profile 150x33mm ($\pm 1\text{mm}$) = 2,230 Kg/m 150x33mm Light Greige ($\pm 1\text{mm}$) = 2,230 Kg/m</p> <p>Alu Profile 38x20mm = 0,540 Kg/m U38x20mm = 0,361 Kg/m</p>

TECHNICAL FEATURES

OPTIONAL ARCHITECTURAL PROFILES

	TECNODECK PROFILE 30x30mm	
	Alloy	Wood Plastic Composite
	Weight (Kg/m)	0,534
	Density (Kg/dm ³)	1,33
	Tensile Strength (MPa)	22,5
	Modulus of Elasticity (MPa)	2400
	Inercia Momentum X (mm ⁴)	5,42E+04
	Inercia Momentum Y (mm ⁴)	5,42E+04

	TECNODECK PROFILE 50x50mm	
	Alloy	Wood Plastic Composite
	Weight (Kg/m)	1,152
	Density (Kg/dm ³)	1,33
	Tensile Strength (MPa)	22,5
	Modulus of Elasticity (MPa)	2400
	Inercia Momentum X (mm ⁴)	3,08E+05
	Inercia Momentum Y (mm ⁴)	3,08E+05

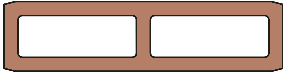
	TECNODECK PROFILE 100x25mm	
	Alloy	Wood Plastic Composite
	Weight (Kg/m)	1,624
	Density (Kg/dm ³)	1,33
	Tensile Strength (MPa)	22,5
	Modulus of Elasticity (MPa)	2400
	Inercia Momentum X (mm ⁴)	1,05E+05
	Inercia Momentum Y (mm ⁴)	1,16E+06

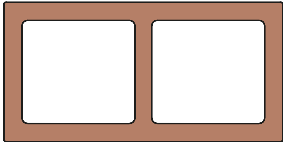
	TECNODECK PROFILE 100x50mm	
	Alloy	Wood Plastic Composite
	Weight (Kg/m)	2,612
	Density (Kg/dm ³)	1,33
	Tensile Strength (MPa)	22,5
	Modulus of Elasticity (MPa)	2400
	Inercia Momentum X (mm ⁴)	7,01E+05
	Inercia Momentum Y (mm ⁴)	2,14E+06

TECHNICAL FEATURES

OPTIONAL ARCHITECTURAL PROFILES

	TECNODECK PROFILE 150x50mm	
	Alloy	Wood Plastic Composite
	Weight (Kg/m)	3,655
	Density (Kg/dm ³)	1,33
	Tensile Strength (MPa)	22,5
	Modulus of Elasticity (MPa)	2400
	Inercia Momentum X (mm ⁴)	1,03E+06
	Inercia Momentum Y (mm ⁴)	6,45E+06

	TECNODECK PROFILE 200x80mm	
	Alloy	Wood Plastic Composite
	Weight (Kg/m)	5,877
	Density (Kg/dm ³)	1,33
	Tensile Strength (MPa)	22,5
	Modulus of Elasticity (MPa)	2400
	Inercia Momentum X (mm ⁴)	4,42E+06
	Inercia Momentum Y (mm ⁴)	1,85E+07

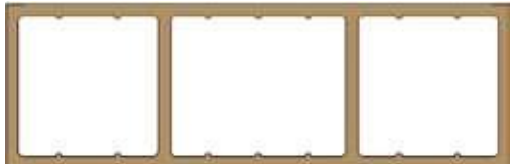
	TECNODECK PROFILE 300x100mm	
	Alloy	Wood Plastic Composite
	Weight (Kg/m)	8,102
	Density (Kg/dm ³)	1,33
	Tensile Strength (MPa)	22,5
	Modulus of Elasticity (MPa)	2400
	Inercia Momentum X (mm ⁴)	1,02E+07
	Inercia Momentum Y (mm ⁴)	5,81E+07

	TECNODECK PROFILE 150x33mm	
	Alloy	Wood Plastic Composite
	Weight (Kg/m)	2,230
	Density (Kg/dm ³)	1,33
	Tensile Strength (MPa)	22,5
	Modulus of Elasticity (MPa)	2400
	Inercia Momentum X (mm ⁴)	1,56E+05
	Inercia Momentum Y (mm ⁴)	2,69E+06

TECHNICAL FEATURES

OPTIONAL REINFORCEMENT PROFILES

TECNODECK ALU PROFILE 20x20mm	
Alloy	6060 T6
Weight (Kg/m)	0,386
Density (Kg/dm ³)	2,7
Yield Strength (MPa)	150
Tensile Strength (MPa)	190
Vickers Hardness	60
Modulus of Elasticity (MPa)	70000
Modulus of Rigidity (MPa)	27000
Inercia Momentum X (mm ⁴)	7,77E+03
Inercia Momentum Y (mm ⁴)	7,77E+03

TECNODECK ALU PROFILE 38x38mm	
Alloy	6060 T6
Weight (Kg/m)	0,656
Density (Kg/dm ³)	2,7
Yield Strength (MPa)	150
Tensile Strength (MPa)	190
Vickers Hardness	60
Modulus of Elasticity (MPa)	70000
Modulus of Rigidity (MPa)	27000
Inercia Momentum X (mm ⁴)	4,88E+04
Inercia Momentum Y (mm ⁴)	4,84E+04

TECNODECK ALU PROFILE 38x10mm	
Alloy	6060 T6
Weight (Kg/m)	0,390
Density (Kg/dm ³)	2,7
Yield Strength (MPa)	150
Tensile Strength (MPa)	190
Vickers Hardness	60
Modulus of Elasticity (MPa)	70000
Modulus of Rigidity (MPa)	27000
Inercia Momentum X (mm ⁴)	1,82E+03
Inercia Momentum Y (mm ⁴)	2,35E+04

TECHNICAL FEATURES

OPTIONAL REINFORCEMENT PROFILES

TECNODECK ALU PROFILE 38x20mm	
	
Alloy	6060 T6
Weight (Kg/m)	0,530
Density (Kg/dm ³)	2,7
Yield Strength (MPa)	150
Tensile Strength (MPa)	190
Vickers Hardness	60
Modulus of Elasticity (MPa)	70000
Modulus of Rigidity (MPa)	27000
Inercia Momentum X (mm ⁴)	2,61E+04
Inercia Momentum Y (mm ⁴)	4,12E+04

TECNODECK ALU PROFILE 35x20mm	
	
Alloy	6060 T6
Weight (Kg/m)	0,395
Density (Kg/dm ³)	2,7
Yield Strength (MPa)	150
Tensile Strength (MPa)	190
Vickers Hardness	60
Modulus of Elasticity (MPa)	70000
Modulus of Rigidity (MPa)	27000
Inercia Momentum X (mm ⁴)	9,68E+03
Inercia Momentum Y (mm ⁴)	2,36E+04

TECNODECK ALU PROFILE 45x35mm	
	
Alloy	6060 T6
Weight (Kg/m)	0,821
Density (Kg/dm ³)	2,7
Yield Strength (MPa)	150
Tensile Strength (MPa)	190
Vickers Hardness	60
Modulus of Elasticity (MPa)	70000
Modulus of Rigidity (MPa)	27000
Inercia Momentum X (mm ⁴)	5,90E+04
Inercia Momentum Y (mm ⁴)	8,77E+04

TECHNICAL FEATURES

OPTIONAL REINFORCEMENT PROFILES

TECNODECK ALU PROFILE 60x40mm	
Alloy	6060 T6
Weight (Kg/m)	1,037
Density (Kg/dm ³)	2,7
Yield Strength (MPa)	150
Tensile Strength (MPa)	190
Vickers Hardness	60
Modulus of Elasticity (MPa)	70000
Modulus of Rigidity (MPa)	27000
Inercia Momentum X (mm ⁴)	1,93E+05
Inercia Momentum Y (mm ⁴)	1,02E+05

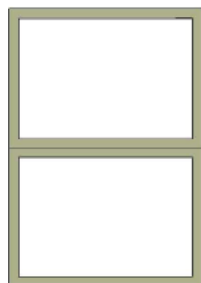

TECNODECK ALU PROFILE 60x60mm	
Alloy	6060 T6
Weight (Kg/m)	1,253
Density (Kg/dm ³)	2,7
Yield Strength (MPa)	150
Tensile Strength (MPa)	190
Vickers Hardness	60
Modulus of Elasticity (MPa)	70000
Modulus of Rigidity (MPa)	27000
Inercia Momentum X (mm ⁴)	2,60E+05
Inercia Momentum Y (mm ⁴)	2,60E+05



TECNODECK ALU PROFILE 80x80mm	
Alloy	6060 T6
Weight (Kg/m)	1,685
Density (Kg/dm ³)	2,7
Yield Strength (MPa)	150
Tensile Strength (MPa)	190
Vickers Hardness	60
Modulus of Elasticity (MPa)	70000
Modulus of Rigidity (MPa)	27000
Inercia Momentum X (mm ⁴)	6,33E+05
Inercia Momentum Y (mm ⁴)	6,33E+05



TECHNICAL FEATURES

OPTIONAL REINFORCEMENT PROFILES

TECNODECK ALU PROFILE 100x40mm	
Alloy	6060 T6
Weight (Kg/m)	1,110
Density (Kg/dm ³)	2,7
Yield Strength (MPa)	150
Tensile Strength (MPa)	190
Vickers Hardness	60
Modulus of Elasticity (MPa)	70000
Modulus of Rigidity (MPa)	27000
Inercia Momentum X (mm ⁴)	1,24E+05
Inercia Momentum Y (mm ⁴)	5,19E+05



TECHNICAL FEATURES

OPTIONAL REINFORCEMENT PROFILES

	TECNODECK ZN U PROFILE 20x20/1,5mm	
	Alloy	Stell S220GD Z200
	Weight (Kg/m)	0,867
	Density (Kg/dm ³)	7,9
	Yield Strength (MPa)	220
	Tensile Strength (MPa)	300
	Modulus of Elasticity (MPa)	210
	Inercia Momentum X (mm ⁴)	6,26E+03
	Inercia Momentum Y (mm ⁴)	6,26E+03

	TECNODECK ZN U PROFILE 38x38/2mm	
	Alloy	Stell S220GD Z200
	Weight (Kg/m)	1,697
	Density (Kg/dm ³)	7,9
	Yield Strength (MPa)	220
	Tensile Strength (MPa)	300
	Modulus of Elasticity (MPa)	210
	Inercia Momentum X (mm ⁴)	3,26E+04
	Inercia Momentum Y (mm ⁴)	5,41E+04

	TECNODECK ZN U PROFILE 35x35/2mm	
	Alloy	Stell S220GD Z200
	Weight (Kg/m)	1,397
	Density (Kg/dm ³)	7,9
	Yield Strength (MPa)	220
	Tensile Strength (MPa)	300
	Modulus of Elasticity (MPa)	210
	Inercia Momentum X (mm ⁴)	1,93E+04
	Inercia Momentum Y (mm ⁴)	2,22E+04

TECHNICAL FEATURES

OPTIONAL REINFORCEMENT PROFILES

TECNODECK ZN U PROFILE 45x35/2mm	
Alloy	Stell S220GD Z200
Weight (Kg/m)	1,871
Density (Kg/dm ³)	7,9
Yield Strength (MPa)	220
Tensile Strength (MPa)	300
Modulus of Elasticity (MPa)	210
Inercia Momentum X (mm ⁴)	5,25E+04
Inercia Momentum Y (mm ⁴)	5,03E+04

TECNODECK ZN U PROFILE 60x40/2mm	
Alloy	Stell S220GD Z200
Weight (Kg/m)	2,424
Density (Kg/dm ³)	7,9
Yield Strength (MPa)	220
Tensile Strength (MPa)	300
Modulus of Elasticity (MPa)	210
Inercia Momentum X (mm ⁴)	9,25E+04
Inercia Momentum Y (mm ⁴)	1,16E+05

TECNODECK ZN U PROFILE 60x60mm/2	
Alloy	Stell S220GD Z200
Weight (Kg/m)	2,732
Density (Kg/dm ³)	7,9
Yield Strength (MPa)	220
Tensile Strength (MPa)	300
Modulus of Elasticity (MPa)	210
Inercia Momentum X (mm ⁴)	1,34E+05
Inercia Momentum Y (mm ⁴)	2,27E+05

TECHNICAL FEATURES

OPTIONAL REINFORCEMENT PROFILES

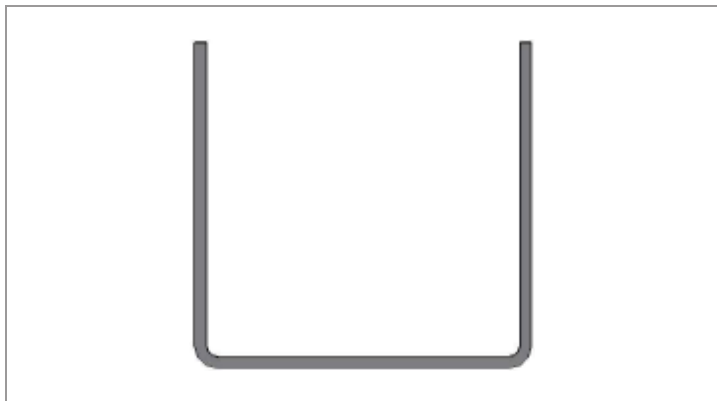
TECNODECK ZN U PROFILE 80x80/2mm

Alloy	Stell S220GD Z200
Weight (Kg/m)	3,688
Density (Kg/dm ³)	7,9
Yield Strength (MPa)	220
Tensile Strength (MPa)	300
Modulus of Elasticity (MPa)	210
Inercia Momentum X (mm ⁴)	3,24E+05
Inercia Momentum Y (mm ⁴)	5,52E+05

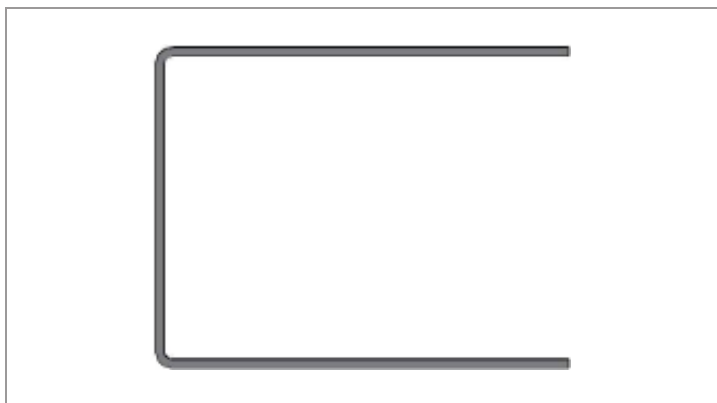
TECNODECK ZN U PROFILE 100x80/2mm

Alloy	Stell S220GD Z200
Weight (Kg/m)	4,320
Density (Kg/dm ³)	7,9
Yield Strength (MPa)	220
Tensile Strength (MPa)	300
Modulus of Elasticity (MPa)	210
Inercia Momentum X (mm ⁴)	6,74E+05
Inercia Momentum Y (mm ⁴)	5,91E+05

TECNODECK BENDED PROFILES

Profile & Dimensions	Minimum Interior Radius	Minimum External Radius	Minimum Length 90° Profile
h x e	R _{int.} (mm)	R _{ext.} (mm)	L _{min} (mm)
50 x 30	500	550	864
50 x 50	500	550	864
85 x 30	800	885	1.390
85 x 85	800	885	1.390
100 x 25	900	1.000	1.571
100 x 50	900	1.000	1.571
FSL 140 x 21	1.250	1.390	2.183
ONE 140 x 25	1.250	1.390	2.183
150 x 50	1.350	1.500	2.356
200 x 80	1.800	2.000	3.142

For projects, Tecnodeck has the technology for to produce bended profiles.

Prices under request.

